

# WIRELESS HYDRONIC DIFFERENTIAL PRESSURE MANOMETER

Liquid and Gas Pressure Measurement,  $\pm 2\%$  of Reading Accuracy

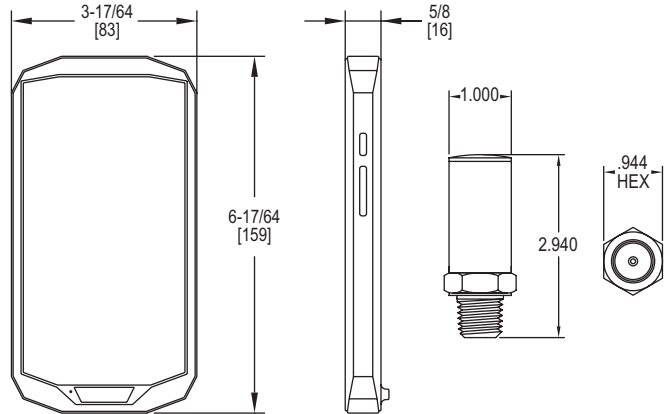

**Series 490W Wireless Hydronic Differential Pressure Manometer** is the most accurate and easy to operate manometer on the market. By using wireless transducers and a versatile handheld, a single operator can monitor and balance a hydronic system in less time than traditional hydronic balancers. The Series 490W utilizes mobile technology to communicate via a Bluetooth connection with the transducers to monitor differential pressure and flow on up to three different valves. Being wireless means there are no hoses to carry, snag on equipment or needing to be drained. The 490W includes the Dwyer Hydronic Application Software that contains valve charts for numerous manufacturers, which converts differential pressure to flow directly on the screen.

## FEATURES/BENEFITS

- Rugged weatherproof handheld housing withstands 1.5 meter drop test.
- Wireless measurement of differential pressure, single pressure and air flow.
- Share logged data directly from handheld over Wi-Fi, GSM or CDMA networks.
- Bluetooth direct wireless communication provides range up to 65 ft (19.8 m).
- The ergonomic design is much lighter and easier to work with, providing greater maneuverability and quick install setup.

## APPLICATIONS

- Refrigerant pressure testing
- Hydronic valve balancing
- Measure pressure drop across pumps
- Measure pressure drop across chiller and coils for freeze protection

## SPECIFICATIONS

**Wireless Distance:** Up to 65' (19.8 m).  
**Service:** Compatible gases & liquids.  
**Wetted Materials:** 316 SS, PTFE, brass.  
**Accuracy:** 2% of reading,  $\pm 1$  psi.  
**Compensated Temperature Range:** 14 to 140°F (-10 to 60°C).  
**Pressure Hysteresis:**  $\pm 0.25\%$  FS.  
**Pressure Range:** See chart.  
**Process Temperature Limits:** -4 to 185°F (-20 to 85°C).  
**Display:** 5" Gorilla® glass 3, touch screen, 1280x720.  
**Resolution:** 0.01 psi.  
**Process Connections:** Two 1/4" male NPT.  
**Power Requirements:** CR2050 or CR2032 lithium battery, user replaceable.  
**Weight:** 2 lb (907 g).  
**Agency Approvals:** CE, FCC.

## MODEL CHART

Model	English Range	Metric Range	Maximum Pressure	Available Engineering Units	Price
<b>490W-6-HKIT</b>	0 to 50 psi, 0 to 200 psi	0 to 344.7 kPa, 0 to 1379 kPa	100 psi (6.89 bar), 400 psi (27.58 bar)	psi, ft w.c., in w.c., Pa, kPa, hPa, cm w.c., mm w.c.	<b>\$2995.00</b>
<b>490W-6-HKIT-NIST</b>	0 to 50 psi, 0 to 200 psi	0 to 344.7 kPa, 0 to 1379 kPa	100 psi (6.89 bar), 400 psi (27.58 bar)	psi, ft w.c., in w.c., Pa, kPa, hPa, cm w.c., mm w.c.	<b>3104.00</b>

## REPLACEMENT TRANSDUCERS

<b>A-490W-1</b>	0 to 15 psi	1.034 bar	30 psig	psi, ft w.c., in w.c., Pa, kPa, hPa, cm w.c., mm w.c.	<b>\$825.00</b>
<b>A-490W-2</b>	0 to 30 psi	2.069 bar	60 psig	psi, ft w.c., in w.c., Pa, kPa, hPa, cm w.c., mm w.c.	<b>825.00</b>
<b>A-490W-3</b>	0 to 50 psi	3.447 bar	100 psig	psi, ft w.c., in w.c., Pa, kPa, hPa, cm w.c., mm w.c.	<b>825.00</b>
<b>A-490W-4</b>	0 to 100 psi	6.895 bar	200 psig	psi, ft w.c., in w.c., Pa, kPa, hPa, cm w.c., mm w.c.	<b>825.00</b>
<b>A-490W-5</b>	0 to 500 psi	34.47 bar	1000 psig	psi, ft w.c., in w.c., Pa, kPa, hPa, cm w.c., mm w.c.	<b>825.00</b>
<b>A-490W-6</b>	0 to 200 psi	13.79 bar	400 psig	psi, ft w.c., in w.c., Pa, kPa, hPa, cm w.c., mm w.c.	<b>825.00</b>

## ACCESSORIES

Model	Description	Price
<b>A-HKIT-500</b>	Piercing gage adapter, 1/8" dia x 1-1/2" length (2 per kit)	<b>\$45.50</b>
<b>A-HKIT-500XL</b>	Piercing gage adapter, 1/8" dia x 3" length (2 per kit)	<b>81.00</b>
<b>A-HKIT-510</b>	Piercing gage adapter, 1/16" dia x 1-1/2" length (2 per kit)	<b>66.00</b>

USA: California Proposition 65  
 ⚠ WARNING: Cancer and Reproductive Harm - www.P65Warnings.ca.gov

Gorilla® is a registered trademark of Corning, Incorporated