

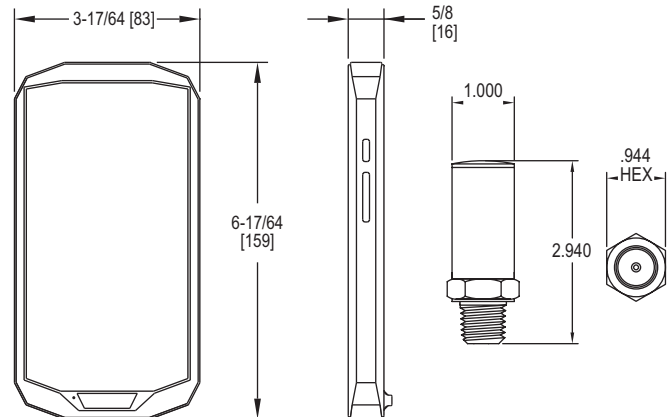

## Series 490W Hydronic Differential Pressure Manometer - Hydronic Application Software

### Specifications - Installation and Operating Instructions



**Series 490W Hydronic Differential Pressure Manometer** is the most accurate and easy to operate manometer on the market. By using wireless transducers and a versatile handheld, a single operator can monitor and balance a hydronic system in less time than traditional hydronic balancers. The Series 490W utilizes mobile technology to communicate via a Bluetooth connection with the transducers to monitor differential pressure and flow on up to three different valves. Being wireless means there are no hoses to carry, snag on equipment or needing to be drained. The 490W includes Dwyer's Hydronic Application Software that contains valve charts for numerous manufacturers, which converts differential pressure to flow directly on the screen.

#### INCLUDED WITH THE 490W

1. Handheld test instrument with Dwyer Hydronic App preloaded onto device
2. Pressure transducers (4 per kit) with case
3. Installation and operating manual
4. 1/4" SAE 45° x 1/4" Male NPT straight adapter (2 per kit)
5. 1/4" Female elbow x 1/4" Male NPT fitting (2 per kit)
6. Piercing gauge adapters [2 per size] (6 per kit)
  - 1/8" DIA x 1-1/2" length
  - 1/8" DIA x 3" length
  - 1/16" x 1-1/2" length
7. 490W fabric carrying case
8. Piercing gauge adapters and fittings case (2 per kit)
9. Charger cable and power adapter for handheld test instrument

#### SPECIFICATIONS

**Wireless Distance:** Up to 65' (19.8 m).  
**Service:** Compatible gases & liquids.  
**Wetted Materials:** 316 SS, PTFE, brass.  
**Accuracy:** 2% of reading,  $\pm 1$  psi.  
**Compensated Temperature Range:** 14 to 140°F (-10 to 60°C).  
**Pressure Hysteresis:**  $\pm 0.25\%$  FS.  
**Pressure Range:** See chart.  
**Process Temperature Limits:** -4 to 185°F (-20 to 85°C).  
**Display:** 5" Gorilla® glass 3, touch screen, 1280x720.  
**Resolution:** 0.01 psi.  
**Process Connections:** Two 1/4" male NPT.  
**Power Requirements:** CR2050 or CR2032 lithium battery, user replaceable.  
**Weight:** 2 lb (907 g).  
**Agency Approvals:** CE, FCC.

MODEL CHART				
Model	English Range	Metric Range	Maximum Range	Available Engineering Units
490W-6-HKIT/NIST	0 to 50 psi, 0 to 200 psi	0 to 344.7 kPa, 0 to 1379 kPa	100 psi (6.89 bar), 400 psi (27.58 bar)	psi, ft w.c., in w.c., Pa, kPa, hPa, cm w.c., mm w.c.
REPLACEMENT TRANSDUCERS				
A-490W-1	0 to 15 psi	1.034 bar	30 psig	psi, ft w.c., in w.c., Pa, kPa, hPa, cm w.c., mm w.c.
A-490W-2	0 to 30 psi	2.069 bar	60 psig	psi, ft w.c., in w.c., Pa, kPa, hPa, cm w.c., mm w.c.
A-490W-3	0 to 50 psi	3.447 bar	100 psig	psi, ft w.c., in w.c., Pa, kPa, hPa, cm w.c., mm w.c.
A-490W-4	0 to 100 psi	6.895 bar	200 psig	psi, ft w.c., in w.c., Pa, kPa, hPa, cm w.c., mm w.c.
A-490W-5	0 to 500 psi	34.47 bar	1000 psig	psi, ft w.c., in w.c., Pa, kPa, hPa, cm w.c., mm w.c.
A-490W-6	0 to 200 psi	13.79 bar	400 psig	psi, ft w.c., in w.c., Pa, kPa, hPa, cm w.c., mm w.c.

Gorilla® is a registered trademark of Corning, Incorporated

## FEATURE OUTLINE

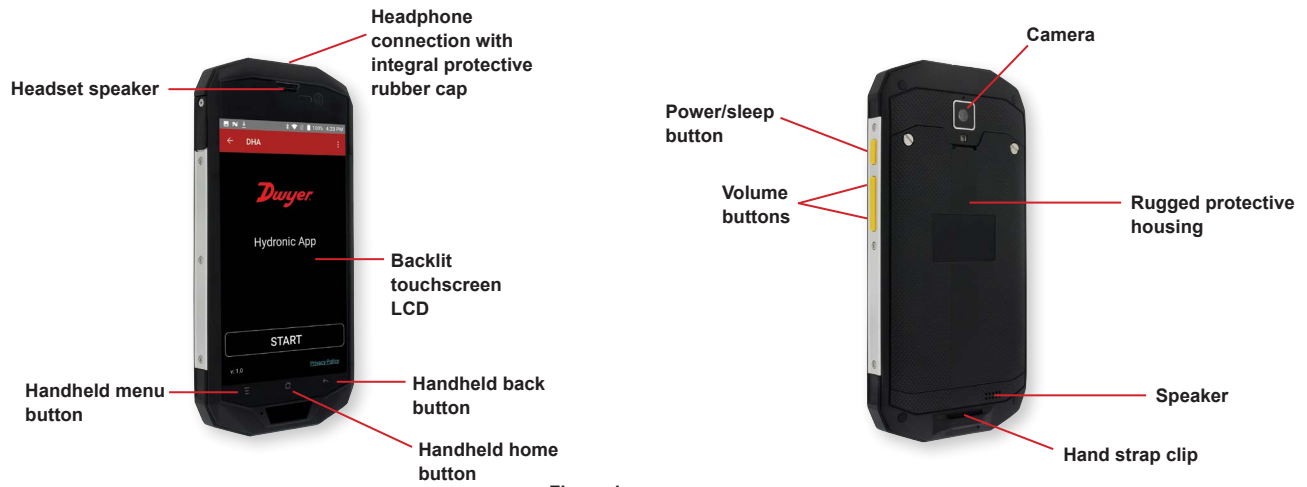

Figure 1

## OPERATION

### Powering On/Off

To turn on the handheld, press and hold the power button. Wait approximately 15 seconds for it to fully power on. Swipe to unlock the unit.

To turn off the unit, either press and hold the power/sleep button and press Power Off when prompted on the LCD or press the reset button.

### Handheld Battery

The universal handheld utilizes an internal rechargeable battery. The battery symbol in the top right of the screen shows the status of the battery.

## TRANSDUCER BATTERY INSTALLATION

The unit is shipped with a CR2050 lithium battery installed. To replace battery, unscrew black top cap from transducer. Tilt transducer to remove old battery. Install new battery and replace top cap.

**NOTICE** Battery life depends on its capacity, operating temperature and signal transmission interval. When battery replacement becomes necessary, use only a CR2050 or CR2032 type such as a Sony CR2050W or CR2032W.

### Low Battery Indicator

A weak battery can cause improper operation or inaccurate measurements. The unit is supplied with a battery that can last up to 2 years, depending on usage. When transducers are sent in for annual recertification, the battery will be replaced.

### NOTICE

When the 490W is received, the handheld test instrument will only have a partial charge. Be sure to fully charge before using. When the battery is low, the battery symbol will turn red. When this occurs, use the included USB charging cable and charging power adapter to recharge the unit.

### NOTICE

The handheld test instrument comes factory paired to the included wireless pressure transducers.

**Dwyer Hydronic App Operation**

First turn on the handheld by pushing the power button (See Figure 1). Once fully powered on, unlock the handheld by swiping the screen to the right. The Dwyer Hydronic app is located at the bottom of the main screen. Click on the icon to open the app.

**NOTICE** When the app is opened, permission messages will pop up. This can be bypassed by pressing ALLOW and can be permanently stopped by adding a Google Play® account in the device's settings menu.

**Valve Selection**

Once the app is open, the Dwyer Hydronic App home screen will be shown. Press the START button. The Valve Selection screen will now be displayed. Press the make button to select a manufacturers valve. Then press the model button to select a valve model. In the list of valve manufacturers, there is an option to choose a manual valve. The flow coefficient (CV) is needed to use the manual valve, see Figure 2. Press the next button to proceed.

**Discovering the wireless pressure transducer**

In the Sensor Discovery screen press the scan button to connect to transducers.

**Note:** In this screen, up to three sets of transducers may be paired simultaneously to read differential pressure or up to six transducers may be paired to read single pressure.

**NOTICE** Be sure the selected transducers' MAC addresses have the same maximum pressure. Each transducer is marked with a red (high) and blue (low) band to distinguish which transducer is high or low. Once the transducers are paired by MAC Address, select the High Side box for the transducer which has the red band. Its paired transducer will automatically be set to the low side. After the high and low transducers are marked, press the Selected box to choose pairs to use.

**NOTICE** The transducers will automatically go into low power/sleep mode to conserve battery energy. The transducers exit low power mode upon receiving communications from the Hydronic Application

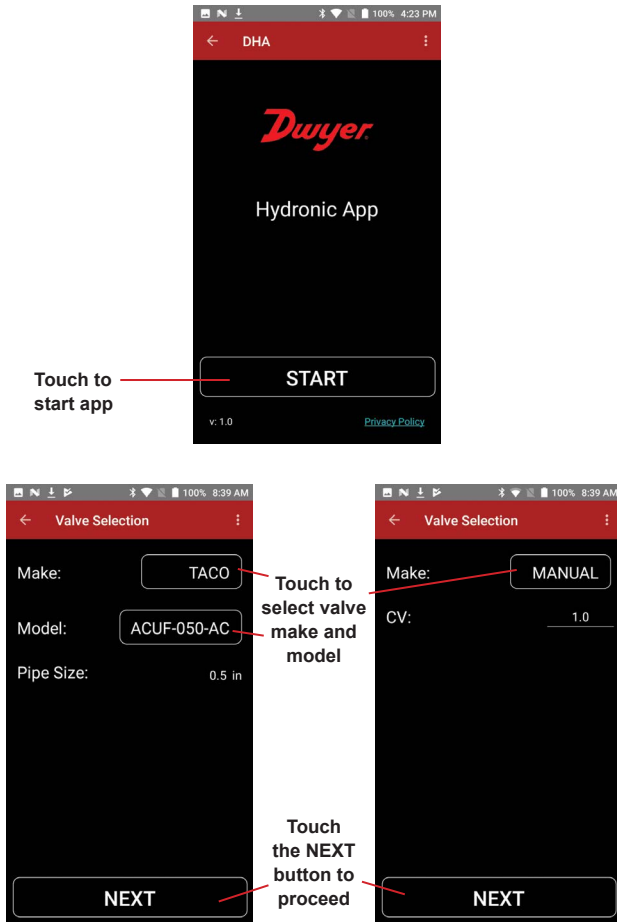

Figure 2

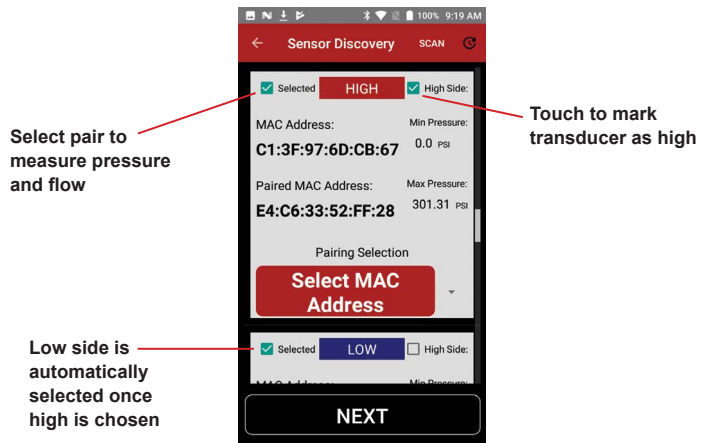
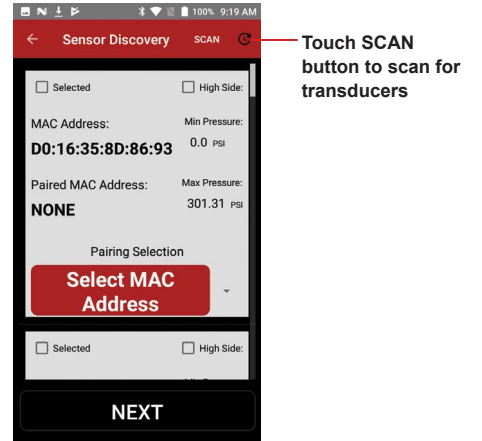
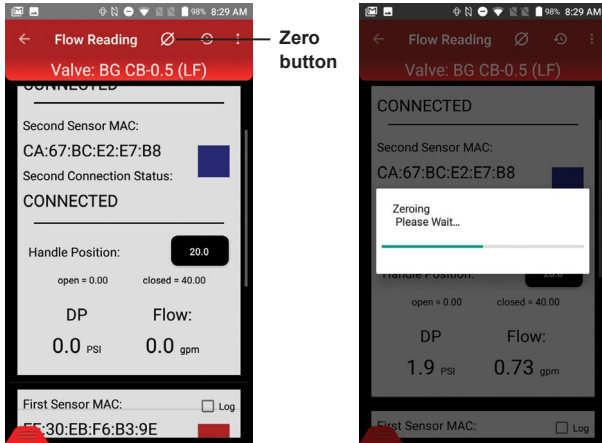

Figure 3

## ZEROING THE TRANSDUCERS

In order for the transducers to be zeroed, place them near the location of the process connection. Note: Be sure to zero transducers outside the process connection without any pressure applied.

In the Hydronic app, press the “Zero” button (Ø) to zero the pressure readings. The zeroing process will begin by displaying a dialog box “Zeroing Please Wait”. Once the dialog box disappears, the transducers can be connected to the process connection to read pressure.



## Reading Differential Pressure and Flow

Data can be collected in the Flow Reading screen after the transducers connection status indicates CONNECTED. The application converts differential pressure to flow directly on the screen.

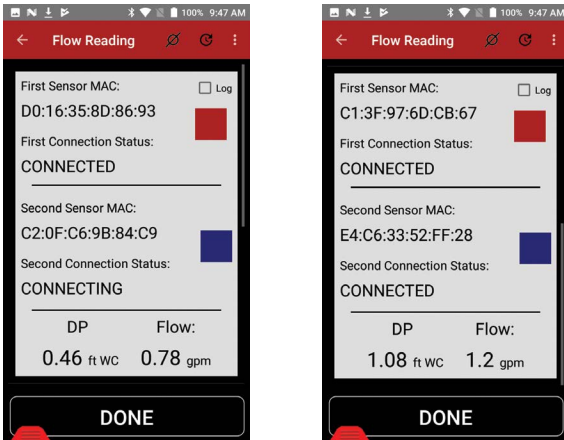

## FCC RF EXPOSURE INFORMATION AND STATEMENT

The SAR limit of USA (FCC) is 1.6 W/kg averaged over one gram of tissue. Device types: S09 (FCC ID: ZHN-W63) has also been tested against this SAR limit. The highest SAR value reported under this standard during product certification for use at the ear is 0.430 W/kg and when properly worn on the body is 0.772 W/kg. This device was tested for typical body-worn operations with the back of the handset kept 1.5 cm from the body. To maintain compliance with FCC RF exposure requirements, use accessories that maintain a 1.5 cm separation distance between the user's body and the back of the handset. The use of belt clips, holsters, and similar accessories should not contain metallic components in its assembly. The use of accessories that do not satisfy these requirements may not comply with FCC RF exposure requirements and should be avoided.

This device complies with Part 15 of the FCC Rules. Operation is subject to the following two conditions: (1) This device may not cause harmful interference, and (2) This device must accept any interference received, including interference that may cause undesired operation.

**Note:** The manufacturer is not responsible for any radio or TV interference caused by unauthorized modification to this equipment. Such modifications could void the user's authority to operate the equipment.

This equipment has been tested and found to comply with the limits for a Class B digital device, pursuant to Part 15 of the FCC Rules. These limits are designed to provide reasonable protection against harmful interference in a residential installation. This equipment generates, uses, and can radiate radio frequency energy and, if not installed and used in accordance with instructions, may cause harmful interference to radio communications. However, there is no guarantee that interference will not occur in a particular installation. If this equipment does cause harmful interference to radio or television reception, which can be determined by turning the equipment off and on, the user is encouraged to try and correct the interference by one of more of the following measures:

- Reorient or relocate the receiving antenna
- Increase the separation between the equipment and receiver
- Connect the equipment into an outlet on a circuit different from that to which the receiver is connected
- Consult the dealer or an experienced radio/TV technician for help

## MAINTENANCE/REPAIR

Upon final installation of the Model 490W, no routine maintenance is required. The Model 490W is not field serviceable and should be returned if repair is needed. Field repair should not be attempted and may void warranty.

## WARRANTY/RETURN

Refer to “Terms and Conditions of Sale” in our catalog and on our website. Contact customer service to receive a Return Goods Authorization Number before shipping the product back for repair. Be sure to include a brief description of the problem plus any additional application notes.